



Download
Manual



Growatt New Energy

Shenzhen Growatt New Energy Co., Ltd
4-13/F, Building A, Sino-German(Europe) Industrial Park, Hangcheng Ave,
Guxing Community, Xixiang Subdistrict, Bao'an District, Shenzhen, China

T +86 755 2747 1942

E service@ginverter.com

W www.ginverter.com

GR-UM-275-A-01

Residential Energy Storage User Manual

AXE 5.0L Battery System

Contents

About this Document

This document describes the installation, electrical connection, operation, commission, maintenance and troubleshooting of AXE 5.0L-C1 and AXE 5.0L-X1 Battery System (hereafter simply put AXE 5.0L). Before installing and operating AXE 5.0L, ensure that you are familiar with product features, functions, and safety precautions provided in this document.

Symbol	Description
 WARNING	Indicates a potentially hazardous situation, if not avoided, could result in serious injury or death.

1 Product Overview

- 1.1 Intended Use
- 1.2 Appearance
- 1.3 Working Principle and Function

2 Safety

- 2.1 Basic security
- 2.2 Safety Precautions
- 2.3 Warning Labels
- 2.4 Emergency Responses

3 Storage and Transportation

- 3.1 Storage Requirements
- 3.2 Transportation Requirement

4 Installation

- 4.1 Installation environment
- 4.2 Basic Installation Requirements
- 4.3 Installation Required Tools
- 4.4 Check
- 4.5 Installation
- 4.6 About mixing old and new batteries in parallel

5 Power on and off the Battery

- 5.1 Power On
- 5.2 Power off

6 Maintenance Guide

- 6.1 Preparation
- 6.2 PACK Replacement
- 6.3 System Failure Information List and Troubleshooting Suggestions

7 Technical Specifications

- Appendix I
- Appendix II

1 Product Overview

1.1 Intended Use

Each AXE 5.0L consists of 100Ah cells which form 51.2V voltage battery module and sixteen serial connection (1P16S). A single cluster can connect up to 10 batteries in parallel, and up to 8 clusters in parallel to expand the capacity and power of the energy storage system. The same type of cell and the same software version of the PACK can be used in parallel. Specifically, the AXE battery system powers the loads through PCS at nighttime without solar; when solar becomes available during daytime, solar energy powers the loads as a priority and store residual solar power into the AXE batter system.

1.2 Appearance

AXE 5.0L consists of battery module (including cell and mechanical parts), battery management system (BMS) as well as power and communication terminals. Product appearance is shown as below.

1.2.1 Dimension

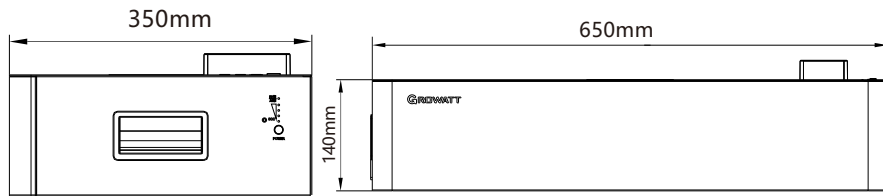

Fig 1.1: Battery size diagram

1.2.2 Introduction to the battery operation panel

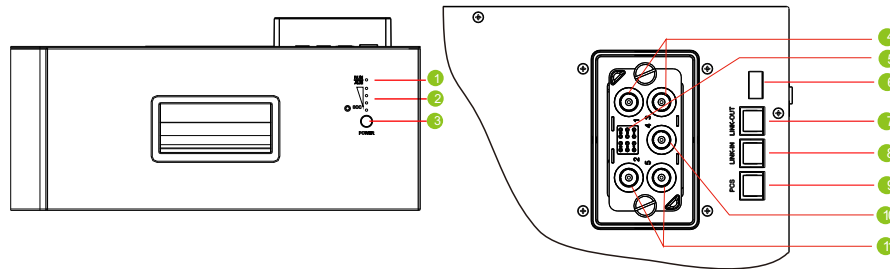

Fig 1.2: Introduction to the battery operation panel

Location	Port	Function
1	Fault light	Display battery alarm and fault status
2	SOC light	Display battery SOC status
3	Power button	Turn the battery on and off
4	Positive terminal	Stands for PACK anode output

5	Communication interface	Communication between battery packs of single cluster
6	USB interface	USB interface for system upgrade
7	Communication interface	Link-out for multi-cluster in parallel communication
8		Link-in for multi-cluster in parallel communication
9		PCS CAN communication
10	GND terminal	Terminal connect to ground
11	Negative terminal	Stands for PACK cathode output

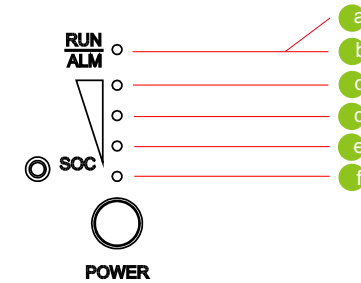

Fig 1.3: LED lights

No.	Name	Color	Description
A	RUN	Green	Normal operation
B	ALM	Red	Failure or protection status
C	LED 4	Blue	76%-100%
D	LED 3	Blue	51%-75%
E	LED 2	Blue	26%-50%
F	LED 1	Blue	0%-25%

1.3 Working Principle and Function

AXE 5.0L is an energy storage unit composed of electrochemical cells, switch button, battery management unit, power and signal terminals, and mechanical parts. It features better charge and discharge performance, more precise status monitor, longer cycle life, and less self-discharge loss than other batteries.

The scalability is very strong, a single cluster can connect up to 10 batteries in parallel, and up to 8 clusters in parallel to expand the capacity and power of the energy storage system.

The whole battery system communicates to Power Conversion System (PCS) via CAN.

- Monitoring: voltage, current and temperature detection of both single cells and PACK.
- Protection and Alarm: protection and alarm when overvoltage, under voltage, over current, over-temperature or under temperature occurs. See Appendix I for details.
- Report: report all alarm and status data to PCS.
- Power off triggered by fault: PACK and PCS communication drop for 25 minutes or under voltage protection for 2 minutes.

2 Safety

Safety information contains in this section must be observed at all times when working on or with batteries. For safety, installers are responsibility to familiarize themselves with this manual and all warnings before installation.

2.1 Basic security

The PACK has been designed and tested in strict rules with international safety certification requirements. Read all safety instructions carefully before any work and obey the rules at all times when working on or with the PACK. Growatt shall not be liable for any consequence caused by the violation of the following:

- Damage occurred during transportation .
- Incorrect transportation, storage, installation and use, or customer fails to convey the correct information about transportation, storage, installation and use to terminal customers.
- Non-professional installation.
- Failure to obey the rules of this operation instructions and safety precautions in this document.
- Unauthorized modifications or removal of the software package.
- PACK tamper label is damaged or product with any part missing (except the authorized disassemble parts).
- Operate and use in extreme environments not allowed in this document.
- Repair, disassemble, or change PACKs without authorization and cause failure.
- Damage to shell labels or modifies date of production.
- PACK fail to be charge for more than six months.
- Damages due to force majeure (such as lightning, earthquakes, fire, and storms).
- Warranty expiration.

2.2 Safety Precautions











2.2.1 Environment requirements



- Do not expose the battery to temperature above 50°C or heat sources.
- Do not install or use the battery in wet locations, moisture , corrosive gases or liquids, such as bathroom.
- Do not expose the battery to direct sunlight for extended periods of time.
- Place battery in safe place away from children and animals.
- Battery power terminals shall not touch conductive objects such as wires.
- Do not dispose the batteries in fire, which may cause an explosion.
- The PACK shall not come in contact with liquids.
- The PACK can only be installed indoors. Regarding indoor installation, please do not install it in the bedroom, living room, kitchen, etc.



2.2.2 Operation Precautions



- Do not touch the PACK with wet hands.
- Do not disassemble the PACK without permission
- Do not crush, drop or puncture the PACK and battery
- Dispose the batteries according to local safety regulations.
- Store and recharge battery in accordance with this manual.
- Ensure the connection of ground wire reliable.
- Remove all metal objects such as watches and rings that could cause a short-circuit before installation, replacement and maintenance.
- The Pack shall be repaired, replaced or maintained by skilled personal that has been recognized.
- When storing or handling batteries ,do not stack batteries without package.
- Do not broke the battery, the released electrolyte may be toxic and is harmful to skin and eyes.
- Packaged batteries should not be stacked more than specified number stipulated on the packing case.
- Do not use damaged, failed or deformed batteries, which may lead to high temperature or even dangerous accidents. Continued operation of damaged battery may result in electrical shock, fire or even worse.

2.3 Warning Labels/Étiquettes d'avertissement



Symbols/ Symboles	Description
	Do not dispose in trash/Ne pas jeter à la poubelle
	Lithium ion battery can be recycled/La batterie lithium-ion peut être recyclée
	Certification in European union area/Certification dans la zone de l'Union européenne
	UK certification/Certification britannique
	Electric shock hazard/Risque de choc électrique
	Explosive gas/Gaz explosif
	May leak corrosive electrolyte/Peut fuir un électrolyte corrosif
	Heavy enough to cause severe injury/Assez lourd pour causer des blessures graves
	Keep the Pack away from children/Gardez le pack hors de portée des enfants
	Make sure the battery polarity well connected/Assurez-vous que la polarité de la batterie est bien connectée



	Do not expose to fire/Ne pas exposer au feu
	Operate as the Manual/Fonctionne comme le manuel

 GROWATT Lithium Ion Battery	
Model	AXE 5.0L-C1
Nominal Voltage	51.2V
Nominal/Rated Capacity	100Ah/90Ah
Nominal/Rated Energy	5000Wh/4600Wh
Rated Current	60A
Ingress Protection	IP20
Operating Ambient Temperature	0°C ~ +50°C
Protective Class	I
Maximum Short Current and Duration	500A, 50us
 Made In China	

 GROWATT Lithium Ion Battery	
Model	AXE 5.0L-X1
Nominal Voltage	51.2V
Nominal/Rated Capacity	100Ah/90Ah
Nominal/Rated Energy	5000Wh/4600Wh
Rated Current	60A
Ingress Protection	IP20
Operating Ambient Temperature	0°C ~ +50°C
Protective Class	I
Maximum Short Current and Duration	500A, 50us
 Made In China	

Battery Module

 GROWATT Lithium Ion Battery	
System Model/ Rated Current/ Nominal Capacity/ Rated Capacity/ Nominal Energy/ Rated Energy	<input type="checkbox"/> AXE 5.0L-C1/60A/100Ah/ 90Ah/5.0kWh/4.6kWh
	<input type="checkbox"/> AXE 10.0L-C1/120A/200Ah/ 180Ah/10.0kWh/9.2kWh
	<input type="checkbox"/> AXE 15.0L-C1/150A/300Ah/ 270Ah/15.0kWh/13.8kWh
	<input type="checkbox"/> AXE 20.0L-C1/150A/400Ah/ 360Ah/20.0kWh/18.4kWh
	<input type="checkbox"/> AXE 25.0L-C1/150A/500Ah/ 450Ah/25.0kWh/23.0kWh
	<input type="checkbox"/> AXE 30.0L-C1/150A/600Ah/ 540Ah/30.0kWh/27.6kWh
	<input type="checkbox"/> AXE 35.0L-C1/150A/700Ah/ 630Ah/35.0kWh/32.2kWh
	<input type="checkbox"/> AXE 40.0L-C1/150A/800Ah/ 720Ah/40.0kWh/36.8kWh
	<input type="checkbox"/> AXE 45.0L-C1/150A/900Ah/ 810Ah/45.0kWh/41.4kWh
	<input type="checkbox"/> AXE 50.0L-C1/150A/1000Ah/ 900Ah/50.0kWh/45.0kWh
Nominal Voltage	51.2V
Ingress Protection	IP20
Operating Ambient Temperature	0°C ~ +50°C
Protective Class	I
 Made In China	

 GROWATT Lithium Ion Battery	
System Model/ Rated Current/ Nominal Capacity/ Rated Capacity/ Nominal Energy/ Rated Energy	<input type="checkbox"/> AXE 5.0L-X1/60A/100Ah/ 90Ah/5.0kWh/4.6kWh
	<input type="checkbox"/> AXE 10.0L-X1/120A/200Ah/ 180Ah/10.0kWh/9.2kWh
	<input type="checkbox"/> AXE 15.0L-X1/150A/300Ah/ 270Ah/15.0kWh/13.8kWh
	<input type="checkbox"/> AXE 20.0L-X1/150A/400Ah/ 360Ah/20.0kWh/18.4kWh
	<input type="checkbox"/> AXE 25.0L-X1/150A/500Ah/ 450Ah/25.0kWh/23.0kWh
	<input type="checkbox"/> AXE 30.0L-X1/150A/600Ah/ 540Ah/30.0kWh/27.6kWh
	<input type="checkbox"/> AXE 35.0L-X1/150A/700Ah/ 630Ah/35.0kWh/32.2kWh
	<input type="checkbox"/> AXE 40.0L-X1/150A/800Ah/ 720Ah/40.0kWh/36.8kWh
	<input type="checkbox"/> AXE 45.0L-X1/150A/900Ah/ 810Ah/45.0kWh/41.4kWh
	<input type="checkbox"/> AXE 50.0L-X1/150A/1000Ah/ 900Ah/50.0kWh/45.0kWh
Nominal Voltage	51.2V
Ingress Protection	IP20
Operating Ambient Temperature	0°C ~ +50°C
Protective Class	I
 Made In China	

 **WARNING**

- Do not disassemble or alter the PACK to avoid heat, explosion or fire.
- Do not use the PACK beyond specific conditions. It might cause heat generation, damage, or deterioration of its performance.
- Do not throw, drop, hit, drive a nail in, stamp on the PACK. It may cause heat generation, explosion, or fire.
- In case of electrolyte leakage, keep leaked electrolyte away from contact with eyes or skin, immediately clean with water and seek help from a doctor.
- Do not put the PACK into a fire. Do not use it or leave it on a place near fire, heaters, or high temperature sources. It may cause over temperature, explosion or fire.
- Do not submerge the PACK in water, or wet the product. It may cause heat generation, explosion, or fire.
- Do not reversely connect the PACK positive(+) and negative(-) terminal.
- Do not short circuit by letting the PACK terminals (+ and -) contact a wire or any metal.
- Do not short circuit by letting the PACK terminals (+ and -) contact a wire or any metal. The unit is heavy enough to cause severe injury.
- Keep out of reach of children or animals.



English

 **Avertissement**

- Ne pas démonter ou modifier le PACK pour éviter toute chaleur, explosion ou incendie.
- Ne pas utiliser le PACK en dehors des conditions spécifiées. Cela pourrait provoquer un chaleur importante, des dommages ou une détérioration des performances de l'appareil.
- Cela peut provoquer un dégagement de chaleur, une explosion ou un incendie.
- En cas de fuite d'électrolyte, ne pas mettre l'électrolyte en contact avec les yeux ou la peau. Nettoyer immédiatement à l'eau et demander l'aide d'un médecin.
- Ne pas mettre le PACK dans un feu. Ne pas l'utiliser près d'une source de chaleur importante. Cela peut provoquer une surchauffe, une explosion ou un incendie.
- Ne pas immerger le PACK dans l'eau, ou mouiller le produit. Cela pourrait provoquer un dégagement de chaleur, une explosion ou un incendie.
- Ne pas inverser la polarité des câbles du pack.
- Ne pas court-circuiter en laissant les bornes du PACK (+ et -) en contact avec un fil ou un métal.
- L'appareil est suffisamment lourd pour provoquer des blessures graves.
- Gardez votre appareil hors de portée des enfants ou des animaux.



French

Fig 2.2: Label

2.4 Emergency Responses

Manufacturer takes foreseeable risk scenarios into consideration and is designed to reduce hazards and dangers. However, if the following situation occurs, do as below:

Situation Occurs	Description and action need
Leakage	Avoid touch of leaking liquid or gas. If you touch the leaking electrolyte, do as below immediately. Inhalation: Evacuate the contaminated area, and seek medical help. Eye contact: Rinse eyes with flowing water for 15 minutes, and seek medical help. Skin contact: Rinse contacted area thoroughly with soap and water, and seek medical help. Ingestion: Vomiting, and seek medical help.
Fire	It's hard for PACK systems ignite spontaneously. If the PACK has caught a fire, do not try to extinguish the fire but evacuate people immediately.
Wet Packs	If PACK is flooded or submerged, do not access it. Contact Growatt or distributor for technical assistance immediately.
Damaged PACKS	Damaged PACKS are dangerous and must be handled with special attention. They are no longer suitable for use and may cause danger to people. If the PACK damaged, stop use it and contact the Growatt or distributor.

3 Storage and Transportation

3.1 Storage Requirements

- Place the PACK follow the identification on the packing case during storage.
- Do not put the PACK upside down or sidelong.
- The defective PACK needs to be separated from other PACKs.
- The storage environment requirements are as follows:
 - 1) Install the PACK in a dry and clean place with proper ventilation.
 - 2) The storage temperature for a short week is between -20°C to 50°C.
 - 3) If you store the PACK over a long period of six months, the storage temperature is between -20°C to 40°C, relative humidity: 5%~85%RH.
 - 4) Place the PACK away from corrosive and organic substances (including gas exposure).
 - 5) Free from direct exposure to sunlight and rain .
 - 6) At least two meters away from heat sources (such as a radiator).
 - 7) Free from exposure to intensive infrared radiation.
- If the PACK has not been used for more than six months, it needs to be charged, The charging procedure is as follows:
 - 1) Identify the PACK that needs charging;
 - 2) Refer to quick installation guidance, complete the installation and wire connection. Ensure PACK in off status during all the steps.
 - 3) Set the power system as “CC≤25A, CV=55.8V” , activate the PACK and start recharging.
 - 4) Recharge until LED2 flicks.
 - 5) Having completed recharge, leave circuit open for five minutes before check voltage. If voltage is not less than 52V, the recharge succe.

3.2 Transportation Requirement

- PACK has been certified in UN38.3 (Section 38.3 of the sixth Revised Edition of the Recommendations on the Transport of Dangerous Goods: Manual of Tests and Criteria) and SN/T 0370.2-2009 (Part 2: Performance Test of the Rules for the Inspection of Packaging for Exporting Dangerous Goods). PACK is classified as category 9 dangerous goods.
- The PACK shall not be transported with other inflammable, explosive or toxic substances.
 - Ensure the original Package and label complete and recognizable.
 - Prohibit direct exposure to sunlight, rain, condensing water caused by temperature difference and mechanical damages.
 - There will be a drop in capacity during transportation and storage.
 - Transportation temperature is between -20°C to 45°C, relative humidity: 5%~85%RH.

Installation 4

 WARNING Avertissement	<ul style="list-style-type: none"> ➤ Ensure to read the Guidance before installation in order to understand product information and safety cautions/ Assurez-vous de lire le guide avant l'installation afin de comprendre les informations sur le produit et les précautions de sécurité; ➤ Operators should be well trained technicians and fully understand the whole photovoltaic system, grid network, working principle and national regional standards/ Les opérateurs doivent être des techniciens bien formés et bien comprendre l'ensemble du système photovoltaïque, le réseau électrique, le principe de fonctionnement et les normes régionales nationales; ➤ Installers must use insulating tools and wear safety equipment/ Les installateurs doivent utiliser des outils isolants et porter des équipements de sécurité; ➤ Device damages caused by failure to comply with storage, transportation, installation and use requirements specified in Guidance are not covered by Warranty/ Les dommages à l'appareil causés par le non-respect des exigences de stockage, de transport, d'installation et d'utilisation spécifiées dans le guide ne sont pas couverts par la garantie. ➤ The PACK can only be installed indoors. Regarding indoor installation, please do not install it in the bedroom, living room, kitchen, etc/ Le PACK ne peut être installé qu'en intérieur. En ce qui concerne l'installation à l'intérieur, veuillez ne pas l'installer dans la chambre, le salon, la cuisine, etc. ➤ Different types of batteries are not recommended to be mixed and used in parallel/ Il est déconseillé de mélanger et d'utiliser différents types de batteries en parallèle. ➤ The battery system cannot be installed, dismantled, and maintained when it has been powered on/ Le système de batterie ne peut pas être installé, démonté et entretenu lorsqu'il a été mis sous tension.
---	---

4.1 Installation environment

The ambient temperature for the installation of the battery system shall be above 0°C, below 50°C, and the humidity shall between 5% and 85%.

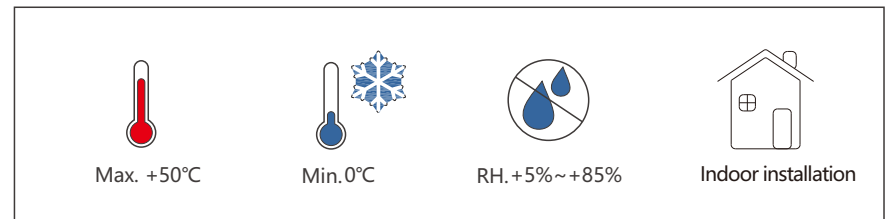
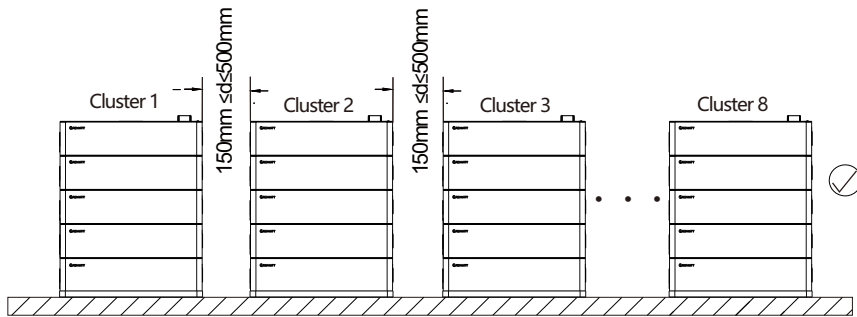
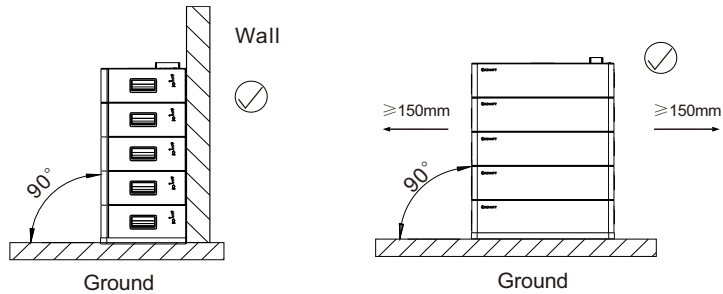

Fig 4.1: Installation environment requirements

4.2 Basic installation requirements



Ground(2~8 clusters installation)

Fig 4.2: Acceptable floor standing installation







WARNING/Avertissemen

Do not turn the PACK upside down, and keep the ground level/ Ne retournez pas le PACK et maintenez le niveau du sol.

4.3 Installation Required Tools

The following tools are required to install the PACK:

		
5mm Allen key	Screw Driver	Wrench
		
Tap Measure	Multimeter	

It is recommended to wear the following safety gear when dealing with the PACK.

		
Insulated Glove	Safety Goggle	Safety Shoes

4.4 Check

4.4.1 Pre-installation Check

Check the package	Check the PACK package before open it. If any abnormality is detected, do not open the Package and contact your distributor.
Check the power	Check and confirm the PACK is powered off before installation.
Check deliverable	Check the quantity of all parts inside according to the package list. If there is any part missing or damaged, please contact your distributor.

4.4.2 Check Packing List

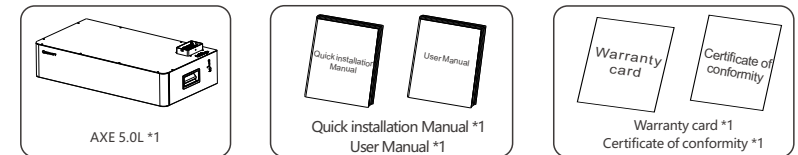
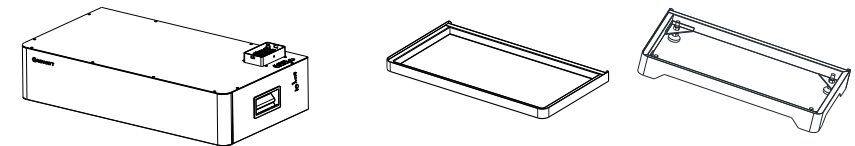

Fig 4.3: AXE 5.0L packing list

4.4.3 Check accessories



ARK 5.0 L

A

ARK 5.0 L Base (Any of them)

B



(2000±25)mm

ARK 5.0 L Cable

C



RJ 45 dust cover

USB dust cover

Fig 4.4: Parts list

Installation Method	Compound Mode
Single cluster installation	A*M+B+C
Floor installation into N columns	A*M+B*N+C*N

Note: "M" means the number of batteries, "N" means the number of clusters.

4.5 Installation

4.5.1 Floor Standing Installation

 WARNING Avertissemen	<p>1) The battery base is required while installing the battery system/ La base de la batterie est requise lors de l'installation du système de batterie.</p> <p>2) The maximum quantity of stacking battery pack is 10, if it exceeds 10, please install them by.</p> <p>3) the way of multiple clusters in parallel/ La quantité maximale de batterie d'empilage est de 10, si elle dépasse 10, veuillez les installer par le biais de plusieurs clusters en parallèle.</p> <p>4) Please install indoors and ensure the level of the ground/ Veuillez installer à l'intérieur et assurer le niveau du sol.</p>
--	--

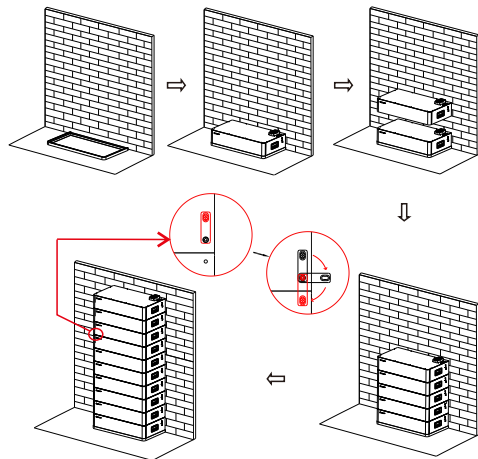



Fig 4.5: Multiple AXE 5.0L with base installation process

- Step 1: Check the ground, make sure that the ground is level, then place the base at the position where it needs to be installed, and keep the base level.
- Step 2: Place the first battery on the base.
- Step 3: Stack the second battery on the first battery, stack the third battery on the second battery, and so on, until all the batteries are installed.
- Step 4: Make sure that all the batteries are aligned, then use a screwdriver to open the connectors on the left end of the batteries, rotate the connector position, and connect the upper and lower battery modules together.

4.5.2 Electrical Connection

 WARNING Avertissemen	<p>➤ Do not forget wear ESD wrist strap and gloves, safety gloves and goggles/ N'oubliez pas de porter un bracelet antistatique et des gants, des gants de sécurité et des lunettes de protection.</p> <p>➤ It is recommended that the power line and communication line between the battery and the PCS should not exceed 2 meters/ Il est recommandé que la ligne électrique et la ligne de communication entre la batterie et le PCS ne dépassent pas 2 mètres.</p>
--	--

4.5.2.1 Communication interface definition:

Item	Crystal head picture	Serial no.	Definition
PCS		1	/
		2	/
		3	GND_COM
		4	CAN_H
		5	CAN_L
		6	GND_COM
		7	WAKE-
		8	WAKE+

4.5.2.2 Single cluster wiring

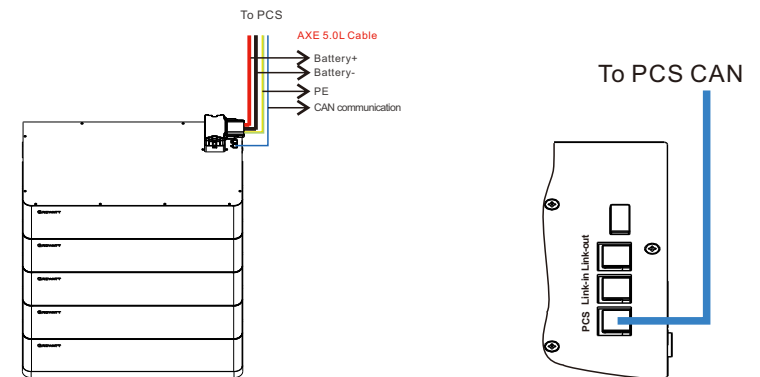

Fig 4.6: Block diagram of a single cluster system

Fig 4.7: Single cluster communication wiring

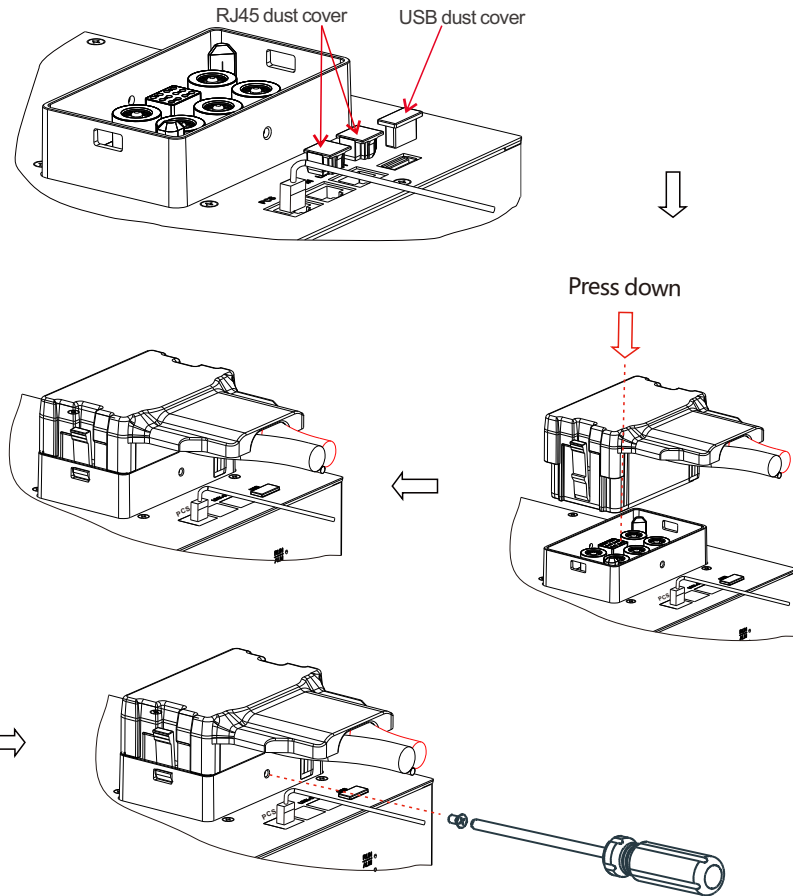

Fig 4.8: Power connection

Note:

- 1) The battery is not allowed to be wired in the running state, and the RUN lights of the battery module should all be off before installation.
- 2) Please install the communication line first, then plug the unused RJ45 port and USB port with a dust cover, and finally install the power line.
- 3) To ensure the safety of the system, do not forget to ground the ground wire.
- 4) We recommend installing a circuit breaker between the PCS and the battery. For the specifications of the circuit breaker, we recommend using a molded case circuit breaker with a rated operating voltage greater than 80Vdc and a rated operating current greater than 200A.
- 5) No cable connection required between battery packs in a single battery cluster.

4.5.2.3 Multi-cluster wiring

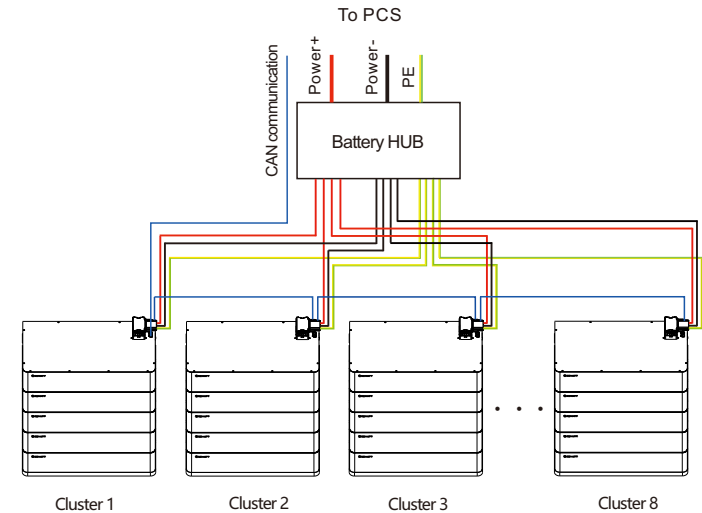

Fig 4.9: Block diagram of multi-cluster system

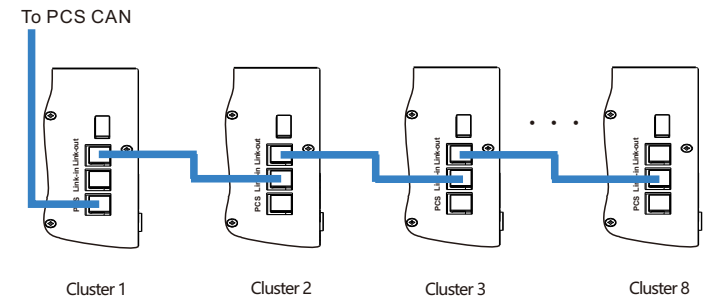

Fig 4.10: Multi-cluster communication wiring

Note:

- 1) Refer to Figure 13 for power line wiring.
- 2) The power combiner box needs to be prepared by the user.
- 3) Please install the communication line first, then plug the unused communication port and USB port with a dust cover, and finally install the power line.
- 4) We recommend installing a circuit breaker between the PCS and each cluster. For the specifications of the circuit breaker, we recommend using a molded case circuit breaker with a rated operating voltage greater than 80Vdc and a rated operating current greater than 200A.

Power on and off the Battery 5

4.5.3 Remove the power cord

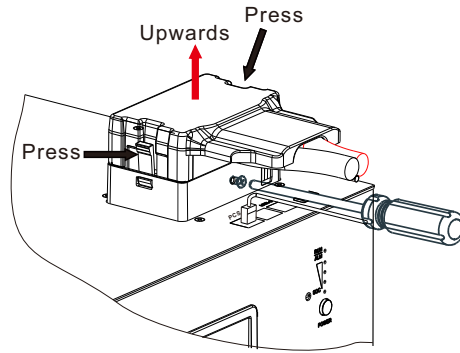

Fig 4.11: Remove the power cord

Step 1: Remove the security screw
 Step 2: Press the buttons on both sides of the terminal at the same time, and then pull it out forcefully

4.6 About mixing old and new batteries in parallel

Please ensure batteries in parallel connection are from the same batch, same model and same manufacturer. Do not mix an old battery with a new battery. Batteries undergone less than 300 cycles are defined as new batteries. The installation time of the newly added battery and the installed battery is less than or equal to 1 year, and the newly added battery must be within the shelf life of 6 months.



WARNING
Avertissemen

- The installation and use of batteries involve much specialized knowledge. Therefore, technicians should be given appropriate technical training and obtain operational certificates in compliance with local laws and regulations. Please ensure technicians have obtained training certificate before operation/ L'installation et l'utilisation des batteries impliquent des connaissances très spécialisées. Par conséquent, les techniciens doivent recevoir une formation technique appropriée et obtenir des certificats opérationnels conformément aux lois et réglementations locales. Veuillez vous assurer que les techniciens ont obtenu un certificat de formation avant l'utilisation.
- Please stand on dry insulating objects and do not wear conductive material such as watches and necklace during operation. Insulated tools should be used/ Veuillez vous tenir sur des objets isolants secs et ne pas porter de matériaux conducteurs tels que des montres et des colliers pendant le fonctionnement. Des outils isolés doivent être utilisés.
- Do not contact any positions with potential difference/ Ne contactez aucune position avec une différence de potentiel.
- Prohibition sign should be hung on the battery: " Non - professionals, do not touch"/ Un panneau d'interdiction doit être accroché sur la batterie : " Non - professionnels, ne pas toucher ".
- If any abnormalities occur during the startup phase, power off the PACK immediately. After problem confirmed, proceed again/ Si des anomalies surviennent pendant la phase de démarrage, mettez immédiatement le PACK hors tension. Une fois le problème confirmé, recommencez.ACK immediately. After problem confirmed, proceed again.
- Make sure the inverter is turned off before checking the PACK/ Assurez-vous que l'onduleur est éteint avant de vérifier le PACK.

5.1 Power On

When multiple batteries are connected in parallel or multiple clusters of batteries are connected in parallel, press one of the battery power buttons and all the batteries connected in parallel can be turned on.

Power on the PACK by pressing power button(t>2S)		
Serial	Procedures	Acceptation criteria
1	Connect the battery and PCS	Make sure the wiring harnesses are well connected
2	Close the breaker of the PACK	Make sure the breaker is ON
3	Press POWER button for three to five seconds. Observe the LED indication on panel.	1. If both RUN/ALM and SOC lights turn on normally, PACK is powered on successfully. 2. If RUN/ALM light turns red, there is a failure and should solve it before power on again.

Maintenance Guide 6

Power on the PACK by PCS		
1	Connect the battery and PCS	Make sure the wiring harnesses are well connected
2	Close the breaker of the PACK	Make sure the breaker is ON
3	Power on the PCS. PCS outputs a wake up signal of 5V or an output main circuit voltage signal of 46-58V	1. If both RUN/ALM and SOC lights turn on normal, PACK powers on successfully. 2. If RUN/ALM light turns red, there is a failure and should solve it before power on again.

5.2 Power off

Press the power button to turn off the PACK and five LED lights will flicker for three times. If under the situation of multiple packs in parallel, only turning off one of the packs then the whole battery system will turn off.

6.1 Preparation

- Tools like safety gloves, cross head driver and socket wrench should be prepared.
 - Turn off and turn on new PACK.
1. If the PACK is power-off. Press power button for 3-5 seconds to turn on.
 2. If the PACK is power-on. Press power button once to turn off.
- Before maintaining the battery, turn off the breaker and press power button once to make sure the PACK is power-off. Follow the installation and wire connection procedures specified above. Ensure wires are properly connected before turn the breaker on. After that, turn on the breaker and press power button of any PACK for 3-5 seconds to check if the system normal works.
3. When installing or maintaining, it is recommended that the battery SOC be at 35% ~ 45% percent.

6.2 PACK Replacement

- Wear safety gloves.
- Open the breaker and power off the PACK.
- Remove your safety screw under the power supply, and disconnect the power cord and CAN communication line of the PACK.
- Remove the safety part at the left end of the battery and lift the PACK upward.
- Put the PACK into the packing box according to the repair procedure and transport the PACK to the designated repair site.
- Install new PACK based on procedure specified in Section 4.

6.3 System Failure Information List and Troubleshooting Suggestions

Error Indication	Error description	Error cause	Suggested actions
ALM			
* (ALM Light Flickers)	Discharge under voltage protection	Single cell voltage below the threshold for under-voltage protection.	There is over discharge risk. User should stop discharging and arrange recharge
	Charge over voltage protection	Single cell voltage exceeding threshold for protection threshold.	1. There is no safety threat; 2. User should stop charging. Idle PACK and it will turn to normal status.
	External CAN Communication failure	Communication loss between PCS and PACK.	1. There is no safety threat and user should stop using battery. 2. Check if PCS and battery communication terminal is well connected. 3. If PCS and PACK cannot communicate when the communication wire is confirmed well connected, user should contact installer to repair battery.

Technical Specifications 7

Functional parameters of AXE 5.0L Energy Storage System are as shown below:

* (ALM Light Flickers)	Interior CAN Communication failure	Communication loss between two parallel	1. Check Can connection between two batteries, CAN connection between Linkin and Linkout;
	Parallel connection failure protection	Communication failure between two parallel connected PACK	1. Check Can connection between two batteries, CAN connection between Battery and PCS;
* (ALM Light on)	Discharge short circuit	External short circuit of PACK	There is safety risk and user should stop using battery User should contact installer to
	Precharger short circuit		
	Precharger overtime circuit		
	Type inconsistency of PACK	The pack type is different	There is safety risk and user should stop using battery User should contact installer to use the same PACK in Parallel.
Main circuit fault	BMS main power circuit failure	There is safety risk and user should stop using battery. User should contact installer to repair battery	

No.	Items	Specification	
1	Parallel number of Battery systems	1	2
2	Battery Model	AXE 5.0L-C1/X1	AXE 10.0L-C1/X1
3	Nominal Capacity/Energy	100Ah/5.0kWh	200Ah/10.0kWh
4	Rated Capacity/Energy	90Ah/4.6kWh	180Ah/9.2kWh
5	Rated Voltage	51.2V	
6	Operating Voltage	46.4 - 57.6V	
7	Rated Charging/discharging current	60A	120A
8	Max Charging/discharging current	80A	150A
9	Over current protection	90A	160A
10	Rated Charging/discharging power	3kW	6kW
11	Max Charging/discharging power	4kW	7.6kW
12	Battery Type	Cobalt Free Lithium Iron Phosphate (LFP)	
13	Operative temperature range	0°C ~ 50°C	
14	Recommended operating	15°C ~ 30°C	
15	Storage conditions	Temperature: -20°C ~ +50°C/ 7 days -20°C ~ 40°C/6 months Humidity: 5% ~ 85%RH Within six months after initial charge	
16	Cooling	Natural cooling	
17	Dimension (W/D/H) (mm)	650*350*140	650*350*280
18	Weight	40kg	80kg
19	Installation	Floor standing installation	
20	Ingress protection	IP 20	
21	Cell safety certification	IEC62619/UL1973	
22	PACK certification	IEC 62619/IEC 63056/ UL1973/CE/UKCA/FCC/RoHS/UN38.3	
23	Charging batteries	See Appendix II	
24	Communication port	CAN	
25	Battery Designation	IFpP/51/161/119 /[(1P16S)1P]M/0 +50/90	IFpP/51/161/119/ [(1P16S)2P]M/0+ 50/90
26	Multiple clusters in parallel	Max.8 Clusters	

No.	Items	Specification	
1	Parallel number of Battery systems	3	4
2	Battery Model	AXE 15.0L-C1/X1	AXE 20.0L-C1/X1
3	Nominal Capacity/Energy	300Ah/15.0kWh	400Ah/20.0kWh
4	Rated Capacity/Energy	270Ah/13.8kWh	360Ah/18.4kWh
5	Rated Voltage	51.2V	
6	Operating Voltage	46.4 - 57.6V	
7	Rated Charging/discharging current	120A	120A
8	Max Charging/discharging current	160A	160A
9	Over current protection	160A	160A
10	Rated Charging/discharging power	7.6kW	7.6kW
11	Max Charging/discharging power	8.1kW	8.1kW
12	Battery Type	Cobalt Free Lithium Iron Phosphate (LFP)	
13	Operative temperature range	0°C~50°C	
14	Recommended operating temperature	15°C~30°C	
15	Storage conditions	Temperature: -20°C ~ +50°C/ 7 days -20°C ~ 40°C/6 months Humidity: 5%~85%RH Within six months after initial charge	
16	Cooling	Natural cooling	
17	Dimension (W/D/H) (mm)	650*350*420	650*350*560
18	Weight	120kg	160kg
19	Installation	Floor standing installation	
20	Ingress protection	IP 20	
21	Cell safety certification	IEC62619/UL1973	
22	PACK certification	IEC 62619/IEC 63056/ UL1973/CE/UKCA/FCC/RoHS/UN38.3	
23	Charging batteries	See Appendix II	
24	Communication port	CAN	
25	Battery Designation	IFpP/51/161/119 /[(1P16S)3P]M/0 +50/90	IFpP/51/161/119/ [(1P16S)4P]M/0+ 50/90
26	Multiple clusters in parallel	Max.8 Clusters	

No.	Items	Specification	
1	Parallel number of Battery systems	5	6
2	Battery Model	AXE 25.0L-C1/X1	AXE 30.0L-C1/X1
3	Nominal Capacity/Energy	500Ah/25.0kWh	600Ah/30.0kWh
4	Rated Capacity/Energy	450Ah/23.0kWh	540Ah/27.6kWh
5	Rated Voltage	51.2V	
6	Operating Voltage	46.4 - 57.6V	
7	Rated Charging/discharging current	120A	120A
8	Max Charging/discharging current	160A	160A
9	Over current protection	160A	160A
10	Rated Charging/discharging power	7.6kW	7.6kW
11	Max Charging/discharging power	8.1kW	8.1kW
12	Battery Type	Cobalt Free Lithium Iron Phosphate (LFP)	
13	Operative temperature range	0°C~50°C	
14	Recommended operating temperature	15°C~30°C	
15	Storage conditions	Temperature: -20°C ~ +50°C/ 7 days -20°C ~ 40°C/6 months Humidity: 5%~85%RH Within six months after initial charge	
16	Cooling	Natural cooling	
17	Dimension (W/D/H) (mm)	650*350*700	650*350*840
18	Weight	200kg	240kg
19	Installation	Floor standing installation	
20	Ingress protection	IP 20	
21	Cell safety certification	IEC62619/UL1973	
22	PACK certification	IEC 62619/IEC 63056/ UL1973/CE/UKCA/FCC/RoHS/UN38.3	
23	Charging batteries	See Appendix II	
24	Communication port	CAN	
25	Battery Designation	IFpP/51/161/119 /[(1P16S)5P]M/0 +50/90	IFpP/51/161/119/ [(1P16S)6P]M/0+ 50/90
26	Multiple clusters in parallel	Max.8 Clusters	

No.	Items	Specification	
1	Parallel number of Battery systems	7	8
2	Battery Model	AXE 35.0L-C1/X1	AXE 40.0L-C1/X1
3	Nominal Capacity/Energy	700Ah/35.0kWh	800Ah/40.0kWh
4	Rated Capacity/Energy	630Ah/32.2kWh	720Ah/36.8kWh
5	Rated Voltage	51.2V	
6	Operating Voltage	46.4 - 57.6V	
7	Rated Charging/discharging current	120A	120A
8	Max Charging/discharging current	160A	160A
9	Over current protection	160A	160A
10	Rated Charging/discharging power	7.6kW	7.6kW
11	Max Charging/discharging power	8.1kW	8.1kW
12	Battery Type	Cobalt Free Lithium Iron Phosphate (LFP)	
13	Operative temperature range	0°C~50°C	
14	Recommended operating temperature	15°C~30°C	
15	Storage conditions	Temperature: -20°C ~ +50°C/ 7 days -20°C ~ 40°C/6 months Humidity: 5%~85%RH Within six months after initial charge	
16	Cooling	Natural cooling	
17	Dimension (W/D/H) (mm)	650*350*980	650*350*1120
18	Weight	280kg	320kg
19	Installation	Floor standing installation	
20	Ingress protection	IP 20	
21	Cell safety certification	IEC62619/UL1973	
22	PACK certification	IEC 62619/IEC 63056/ UL1973/CE/UKCA/FCC/RoHS/UN38.3	
23	Charging batteries	See Appendix II	
24	Communication port	CAN	
25	Battery Designation	IFpP/51/161/119 /[(1P16S)7P]M/0 +50/90	IFpP/51/161/119/ [(1P16S)8P]M/0+ 50/90
26	Multiple clusters in parallel	Max.8 Clusters	

No.	Items	Specification	
1	Parallel number of Battery systems	9	10
2	Battery Model	AXE 45.0L-C1/X1	AXE 50.0L-C1/X1
3	Nominal Capacity/Energy	900Ah/45.0kWh	1000Ah/50.0kWh
4	Rated Capacity/Energy	810Ah/41.4kWh	900Ah/46.0kWh
5	Rated Voltage	51.2V	
6	Operating Voltage	46.4 - 57.6V	
7	Rated Charging/discharging current	120A	120A
8	Max Charging/discharging current	160A	160A
9	Over current protection	160A	160A
10	Rated Charging/discharging power	7.6kW	7.6kW
11	Max Charging/discharging power	8.1kW	8.1kW
12	Battery Type	Cobalt Free Lithium Iron Phosphate (LFP)	
13	Operative temperature range	0°C~50°C	
14	Recommended operating temperature	15°C~30°C	
15	Storage conditions	Temperature: -20°C ~ +50°C/ 7 days -20°C ~ 40°C/6 months Humidity: 5%~85%RH Within six months after initial charge	
16	Cooling	Natural cooling	
17	Dimension (W/D/H) (mm)	650*350*1260	650*350*1400
18	Weight	360kg	400kg
19	Installation	Floor standing installation	
20	Ingress protection	IP 20	
21	Cell safety certification	IEC62619/UL1973	
22	PACK certification	IEC 62619/IEC 63056/ UL1973/CE/UKCA/FCC/RoHS/UN38.3	
23	Charging batteries	See Appendix II	
24	Communication port	CAN	
25	Battery Designation	IFpP/51/161/119 /[(1P16S)9P]M/0 +50/90	IFpP/51/161/119/ [(1P16S)10P]M/0 +50/90
26	Multiple clusters in parallel	Max.8 Clusters	

Appendix I

LED indication Control Mechanism

LED light definition							
Status	Items	SOC indication				RUN/ALM	Remark
		LED1	LED2	LED3	LED4	LED5	
Charge SOC	0%-25%	✱(t=1S)				●	RUN/ALM light on and one SOC lights flicker
	26%-50%	●	✱(t=1S)			●	
	51%-75%	●	●	✱(t=1S)		●	
	76%-99%	●	●	●	✱(t=1S)	●	
	100%	●	●	●	●	●	
Discharge SOC	100%-76%	●	●	●	●	●	
	75%-51%	●	●	●		●	
	50%-26%	●	●			●	
	25%-0%	●				●	
Idle	100%-76%	●	●	●	●	●	
	75%-51%	●	●	●		●	
	50%-26%	●	●			●	
	25%-0%	●				●	
Parallel connection	Parallel connection succeeds					●	RUN/ALM light flicker green
Protection	Cell charge overvoltage alarm	SOC indicates current remaining capacity				✱(t=1S)	RUN/ALM light flicker green
	Cell charge overvoltage protection					✱(t=1S)	RUN/ALM light flicker green
	PACK charge overvoltage alarm					✱(t=1S)	RUN/ALM light flicker green
	PACK charge overvoltage protection					✱(t=1S)	RUN/ALM light flicker green
	Over charge and over discharge alarm					✱(t=1S)	RUN/ALM light flicker green

Over charge and over discharge protection	✱(t=1S)	RUN/ALM light flicker green
Charging current limit does not respond	✱(t=1S)	RUN/ALM light flicker green
Charge and discharge high temperature alarm	✱(t=1S)	RUN/ALM light flicker green
Charge and discharge high temperature protection	✱(t=1S)	RUN/ALM light flicker green
Charge and discharge low temperature alarm	✱(t=1S)	RUN/ALM light flicker green
Charge and discharge low temperature protection	✱(t=1S)	RUN/ALM light flicker green
Cell discharge undervoltage alarm	✱(t=1S)	RUN/ALM light flicker green
Cell discharge undervoltage protection	✱(t=1S)	RUN/ALM light flicker green
PACK discharge undervoltage alarm	✱(t=1S)	RUN/ALM light flicker green
PACK discharge undervoltage protection	✱(t=1S)	RUN/ALM light flicker green
Charge and discharge Overcurrent hardware protection	✱(t=1S)	RUN/ALM light flicker green

	Mos high temperature alarm		✱(t=1S)	RUN/ALM light flicker green
	Mos high temperature protection		✱(t=1S)	RUN/ALM light flicker green
	High temperature environment alarm		✱(t=1S)	RUN/ALM light flicker green
	High temperature environment protection		✱(t=1S)	RUN/ALM light flicker green
	Cell Large voltage difference alarm		✱(t=1S)	RUN/ALM light flicker green
	Cell Large voltage difference protection		✱(t=1S)	RUN/ALM light flicker green
	difference protection between PACK voltage and module voltage		✱(t=1S)	RUN/ALM light flicker green
	Parallel connection over charge and over discharge alarm		✱(t=1S)	RUN/ALM light flicker green
Fault, personnel handling required	Discharge short circuit	SOC indicates current remaining capacity	✱(t=1S)	RUN/ALM light flicker red
	Precharged short circuit		✱(t=1S)	RUN/ALM light flicker red
	Precharged overtime circuit		✱(t=1S)	RUN/ALM light flicker red
	External CAN communication failure		✱(t=1S)	RUN/ALM light flicker red
	Interior CAN communication failure		✱(t=1S)	RUN/ALM light flicker red
	Parallel connection failure		✱(t=1S)	RUN/ALM light flicker red

	Type inconsistency of PACK		✱(t=1S)	RUN/ALM light flicker red
	Batteries failure protection		●	RUN/ALM light stays red
	Voltage sampling anomaly protection		●	RUN/ALM light stays red
	Current sampling fault		●	RUN/ALM light stays red
	Main circuit fault		●	RUN/ALM light stays red

Appendix II

Charging batteries

- 1) Charge with 60A constant current to the highest cell voltage of 3.53V;
- 2) Charge with 25A constant current charging to the highest cell voltage 3.54V;
- 3) Charge with 10A constant current charging to the highest cell voltage 3.55V;
- 4) Charge with 5A constant current charging to the highest cell voltage 3.55V (SOC is 100%)

Shenzhen Growatt New Energy Co., Ltd

4-13/F, Building A, Sino-German(Europe) Industrial Park, Hangcheng Ave, Guxing Community, Xixiang Subdistrict, Bao'an District, Shenzhen, China

T +86 755 2747 1942

E service@ginverter.com

W www.ginverter.com