

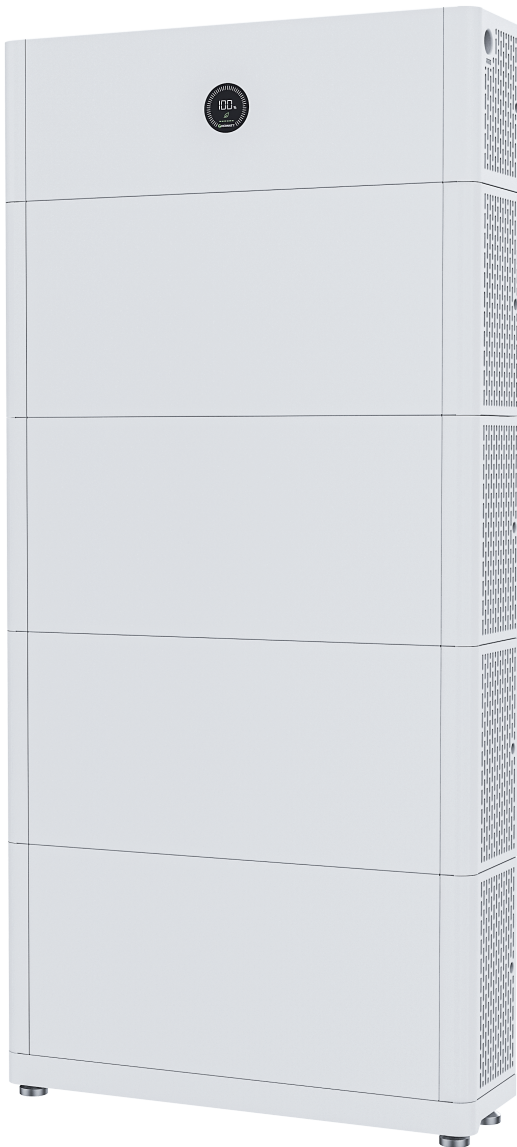

Quick Guide

APX 5.0~30.0P-S0



Environmental conditions



Max. +50°C



Min. -10°C



RH.5%~95%

Installation tools

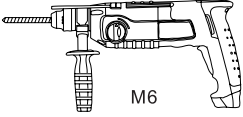

M6



M6 2N • m



M4 1N • m

System size

Unit:mm

APX 55027-P0
(Power Module)

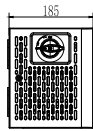
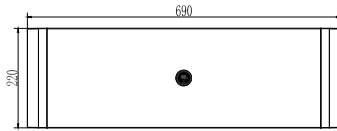

APX 5.0P-B1
(Battery Module)

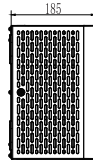
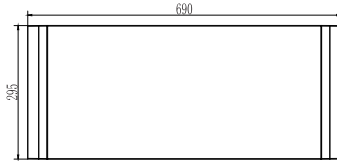

1.Inspection upon delivery

1-1 Checking the APX 55027-P0 packing list (New packaging)

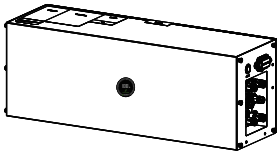

APX 55027-P0 (PM)

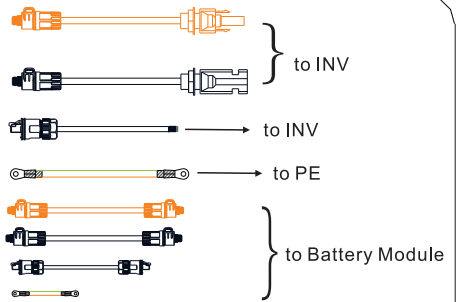

System cable

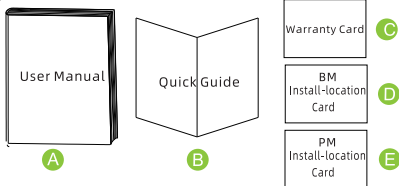

- A** User Manual *1
- B** Quick Guide *1
- C** Warranty Card *1
- D** BM Install-location Card *1
- E** PM Install-location Card *1

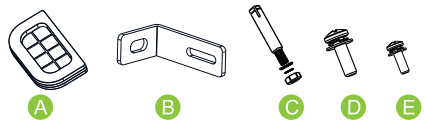

- A** Protective rubber ring *4
- B** Anti tipping plate *2
- C** M6 explosive screw *2
- D** M6x12 stainless steel screws *1
- E** M4x9 stainless steel screws *3

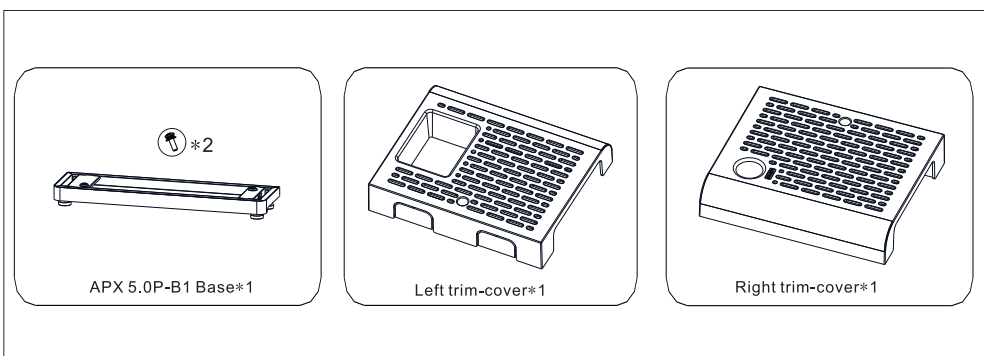

1-2 Check APX 5.0P-B1 List

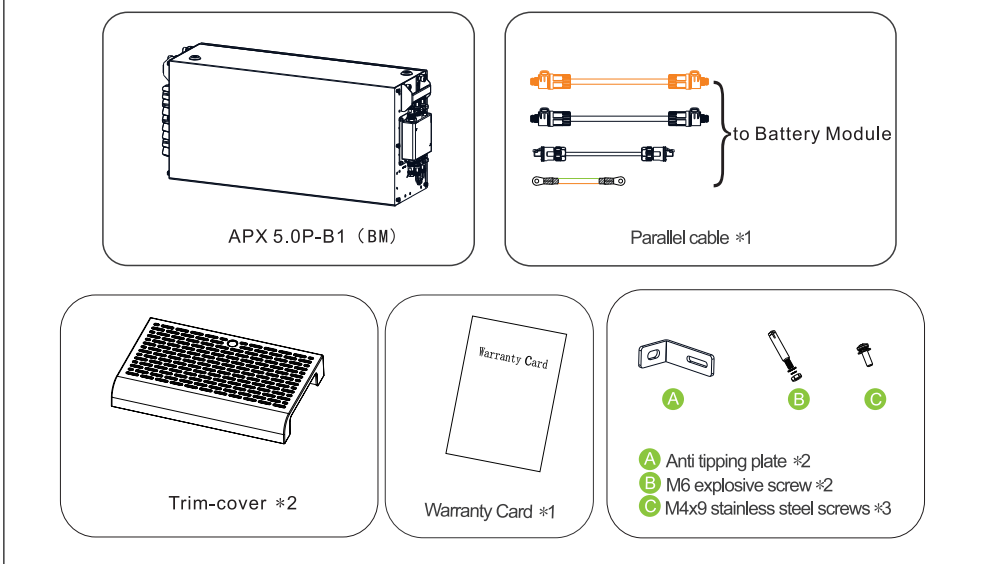

1-3 Check the APX Battery System of different capacities

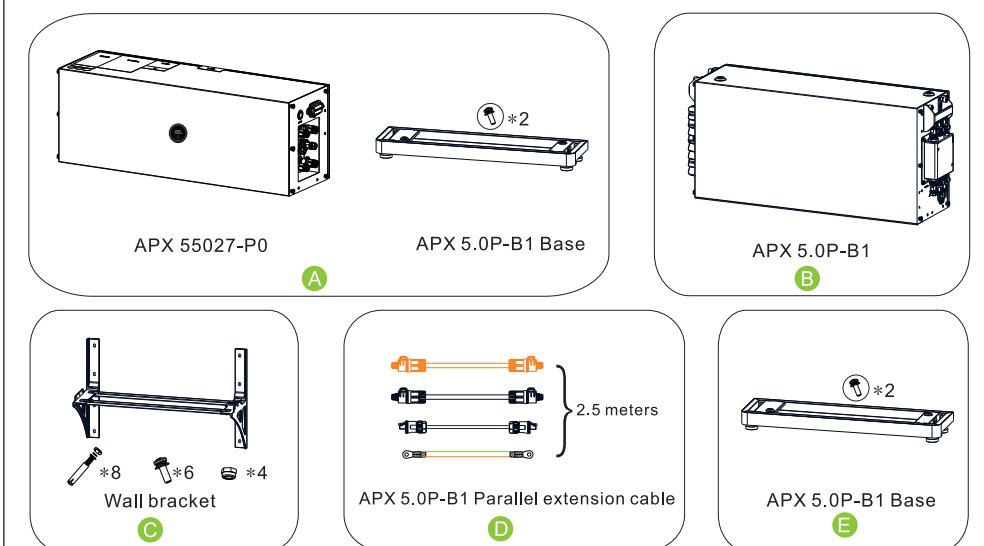

Battery System Capacity	Floor Installation Compound Mode	Wall-Mounted Installation Compound Mode
5kWh	A+B	A+B+C
10kWh	A+B*2	A+B*2+C
15kWh	A+B*3	A+B*3+C
20kWh	A+B*4	A+B*4+C
25kWh	A+B*5+E+D	A+B*5+C*2+D
30kWh	A+B*6+E+D	A+B*6+C*2+D

2. Installation environment requirements

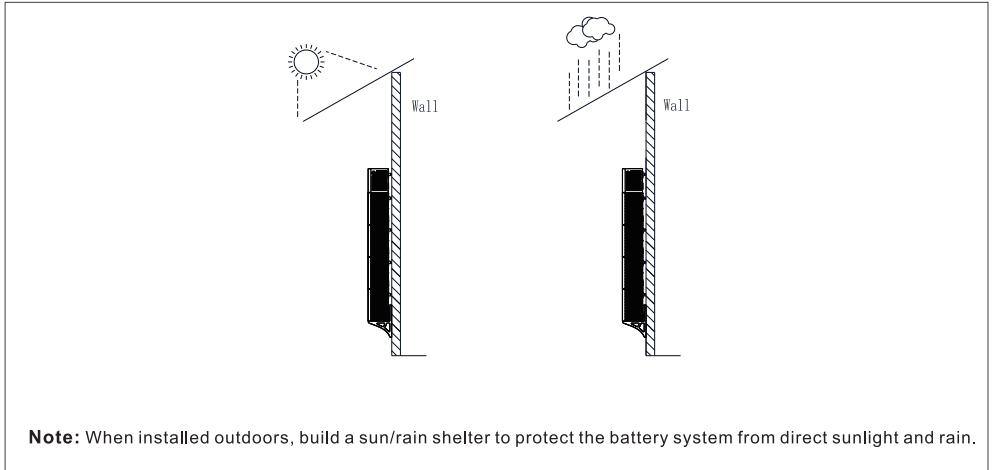

3. Floor-mounted installation

3-1 Installation location requirements

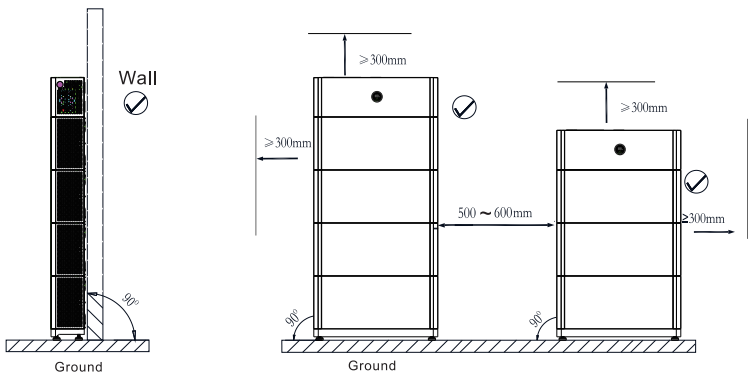

Note: For the floor-mounted installation with the base, a maximum of six battery modules can be configured. If the number of the battery modules to be installed is greater than four, you are advised to install them in 2 columns.

3-2 Installation procedure

Unit:mm

Mounting Hole Dimensions

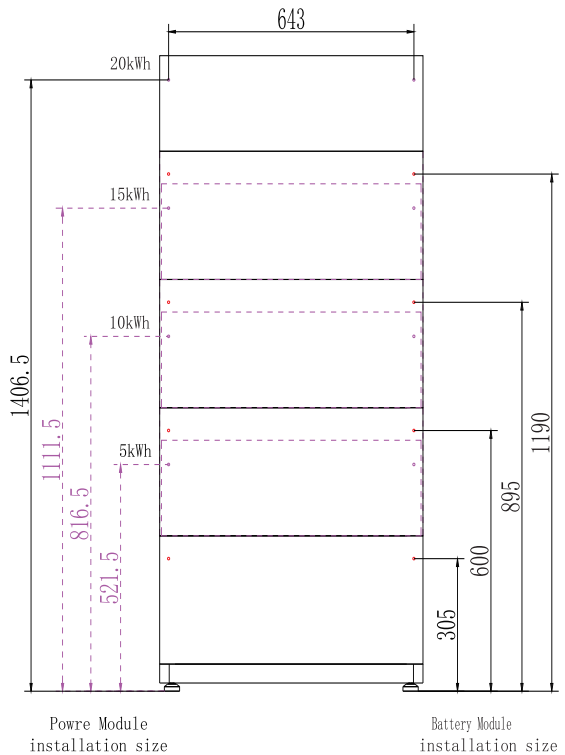
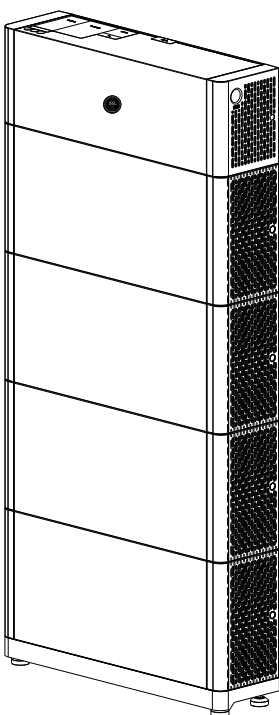

1

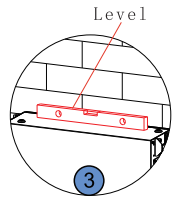
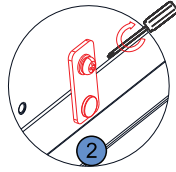
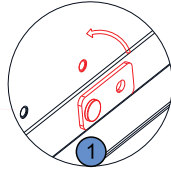
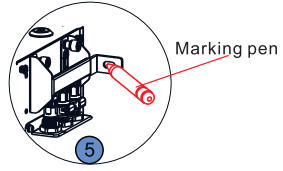
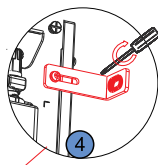
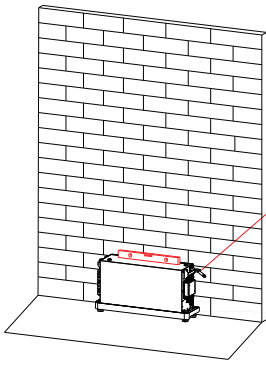

- ① ② Install the connecting pieces on both sides and tighten the two screws .
- ③ Level the battery module using a level.
- ④ Install the anti-tipping plate on both sides and tighten the two screws .
- ⑤ Mark the hole positions

2

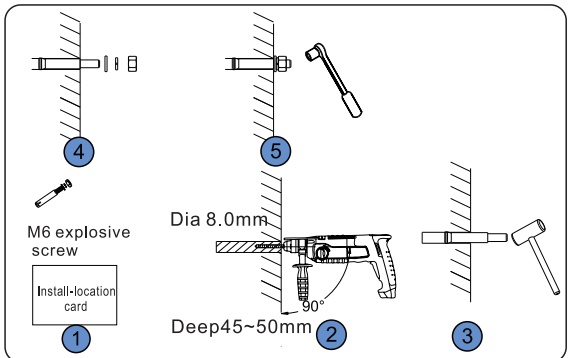
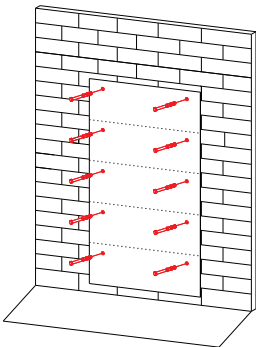

- ① The marking-off template ensures that the alignment marks are properly.
- ② ③ ④ ⑤ Fix the M6 explosive screw in the wall.

3

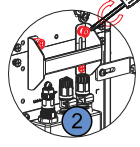
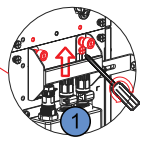
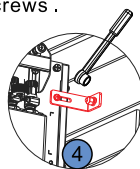
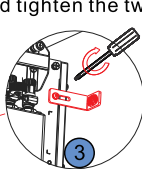
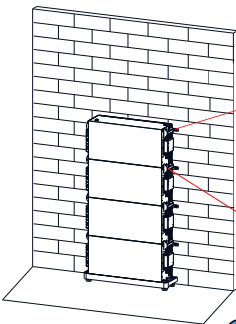

- ③ Install the connecting pieces on both sides and tighten the two screws .
- ④ Secure the module on both sides to the wall.
- ① Loosen two screw, move up handle on both sides.
- ② Tighten the two screws, fix the two battery modules.

4

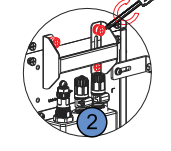
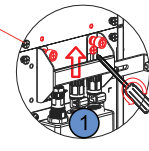
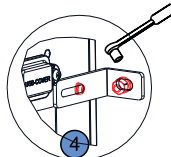
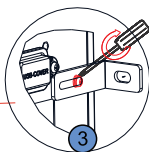
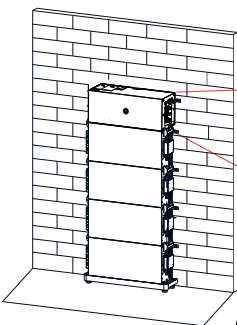

- ③ Install the connecting pieces on both sides and tighten the two screws .
- ④ Secure the module on both sides to the wall.
- ① Loosen two screw, move up handle on both sides.
- ② Tighten the two screws, fix the battery and the power modules.

4. Wall-mounted installation

4-1 Installation location requirements

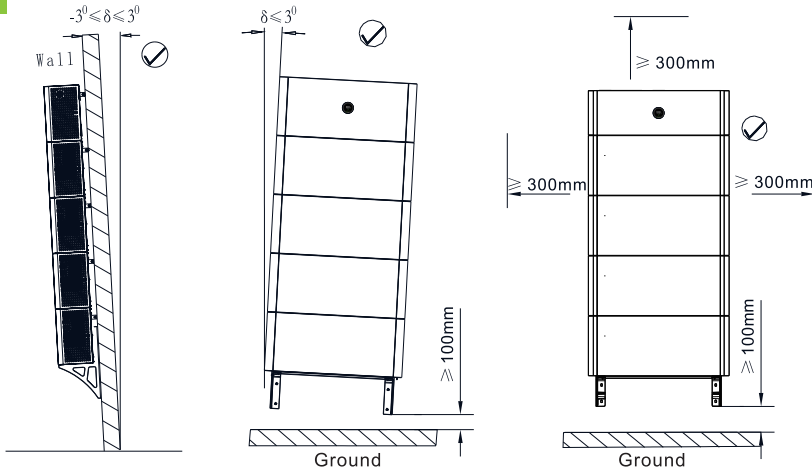

Note: When mounted on the wall, a maximum of six battery modules can be configured. If the number of the battery modules to be installed is greater than four, you are advised to install them in 2 columns. Ensure that the load-bearing capacity of the wall exceeds the total weight of the system (PM weighs 10 kg and each BM weighs 50 kg).

4-2 Installation procedure

Unit:mm

Mounting Hole Dimensions

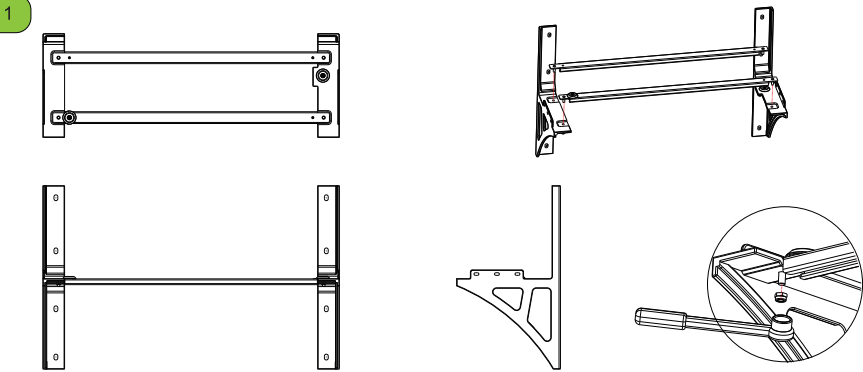
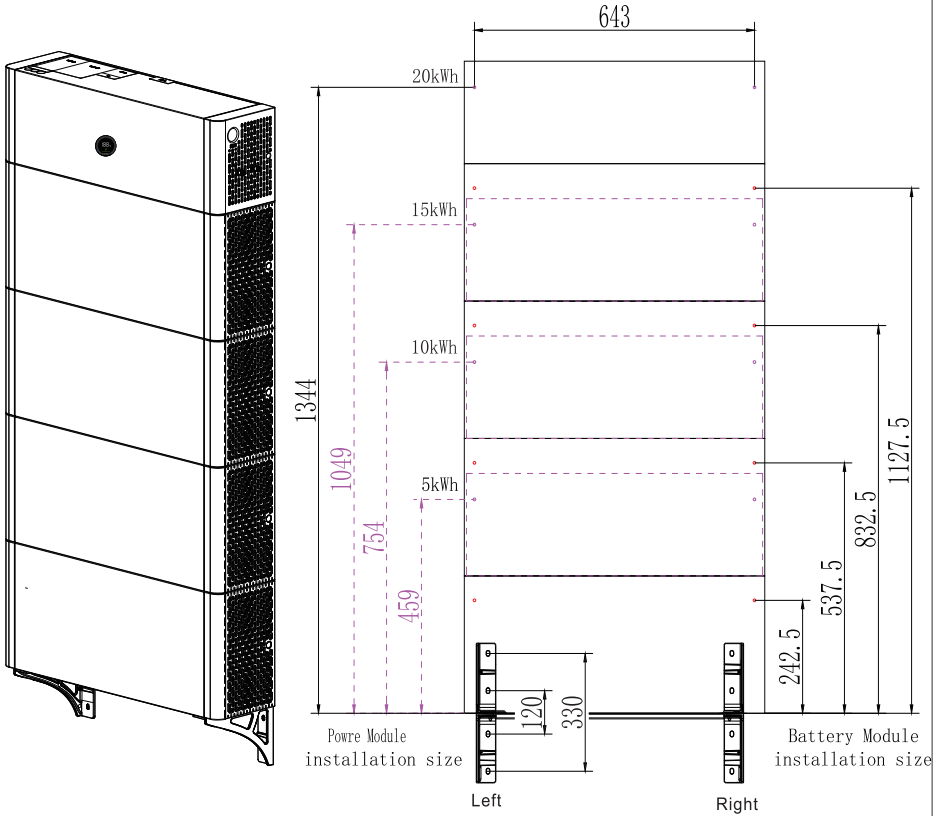

install the wall bracket

2

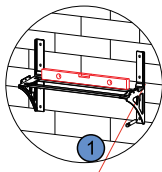
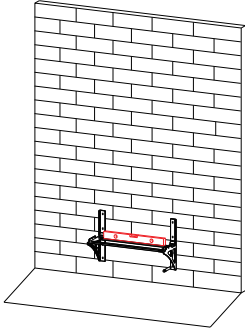

Level

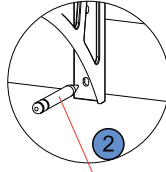

Marking pen

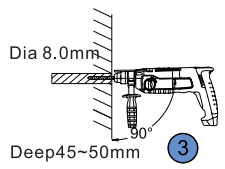

Dia 8.0mm

Deep 45~50mm

- 1 Level the battery Module using a level.
- 2 Mark the hole positions.
- 3 Drilling eight holes.

3

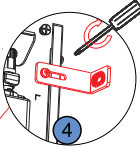
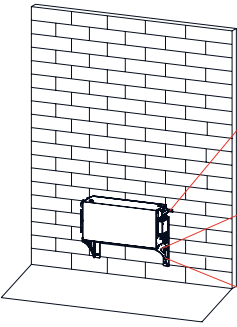

- 4 Install the anti tipping plate on both sides and tighten the two screws.

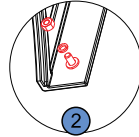
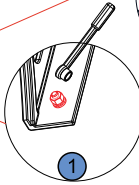
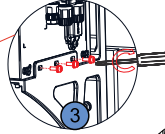

- 1 2 Fix the bracket on the wall.
- 3 Fix the battery module on the bracket.

4

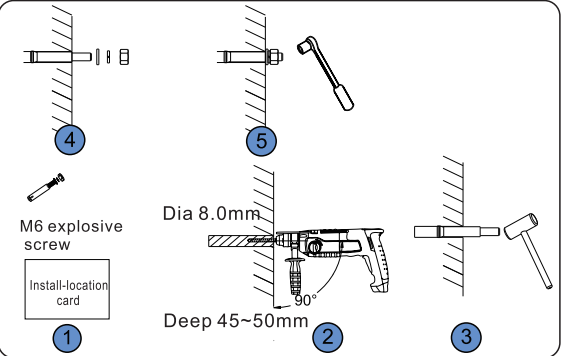
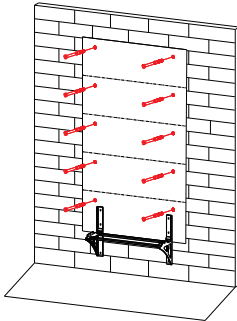

M6 explosive screw

Install-location card

Dia 8.0mm

Deep 45~50mm

- 1 Install-location card ensures alignment marks on the wall.
- 2 3 4 5 Fix the M6 explosive screw in the wall.

5

- 3 Install the connecting pieces on both sides and tighten the two screws.

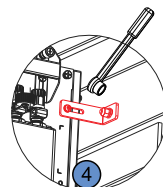
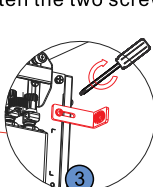
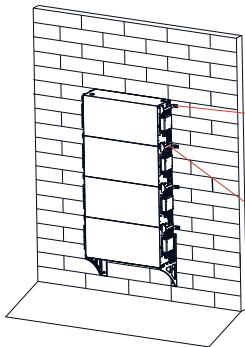

- 4 Secure the module on both sides to the wall.

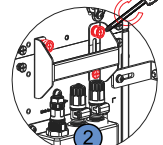
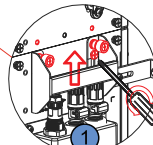

- 1 Loosen two screws, move up handle on both sides.
- 2 Tighten the two screws, fix the two battery modules.

- 3 Install the connecting pieces on both sides and tighten the two screws .

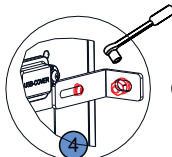
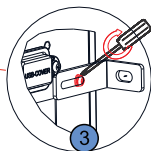
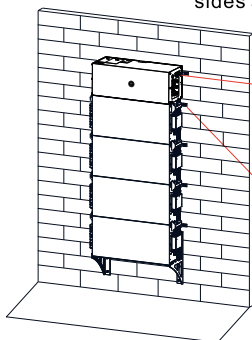

- 4 Secure the module on both sides to the wall.

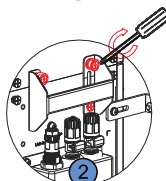
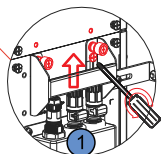

- 1 Loosen two screws, move up handle on both sides.

- 2 Tighten the two screws, fix the battery and the power modules.

5. Cable connection

5-1 APX 55027-P0 terminal & key description

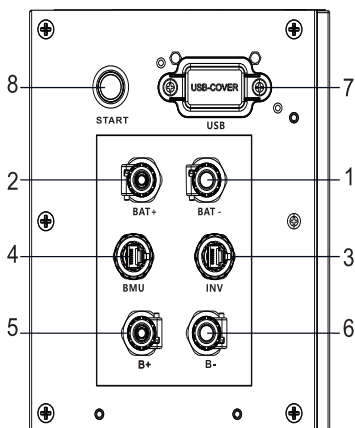

1	BAT -	Battery negative terminal to INV
2	BAT +	Battery positive terminal to INV
3	INV	Inverter communication to INV
4	BMU	Battery module communication to battery(Link-in)module
5	B+	Battery module positive terminal to battery(B+) module
6	B-	Battery module negative terminal to battery(B-) module
7	USB	USB terminal
8	Start	Start key

5-2 APX 5.0P-B1 terminal description

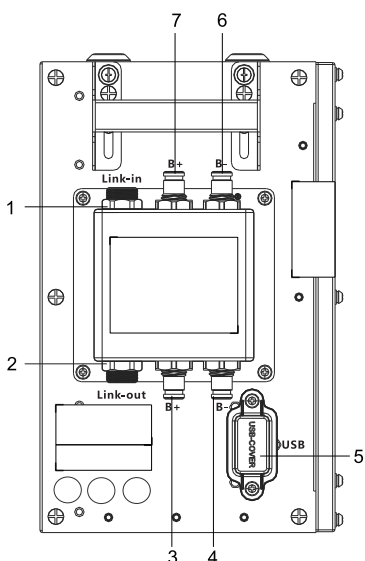

1	Link-in	Link-in communication to another battery(Link-out) or power module(BMU)
2	Link-out	Link-out communication to another battery(Link-in) module
3	B+	Battery positive terminal to another battery(B+) module
4	B-	Battery negative terminal to another battery (B-) module
5	USB	USB terminal
6	B-	Battery negative terminal to another battery(B-) or power module (Module-)
7	B+	Battery positive terminal to another battery(B+) or power module (Module+)

5-3 Battery capacity description

The battery system supports power and capacity expansion. Two power control modules can be connected in parallel. One power control module supports a maximum of four battery expansion modules.

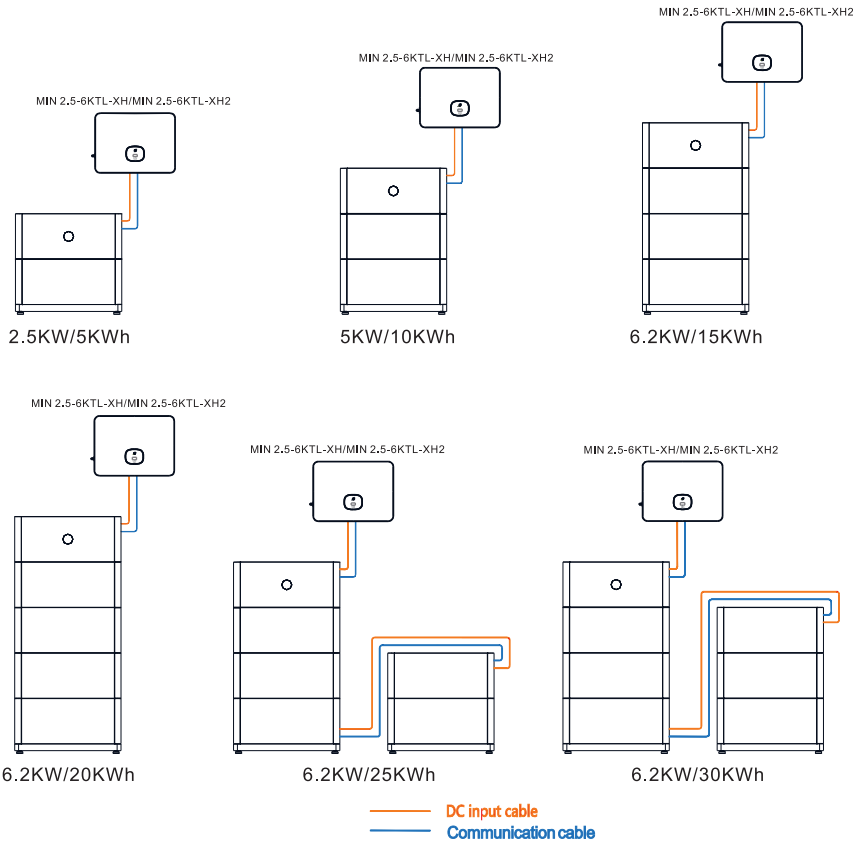

5-4 System wiring diagram

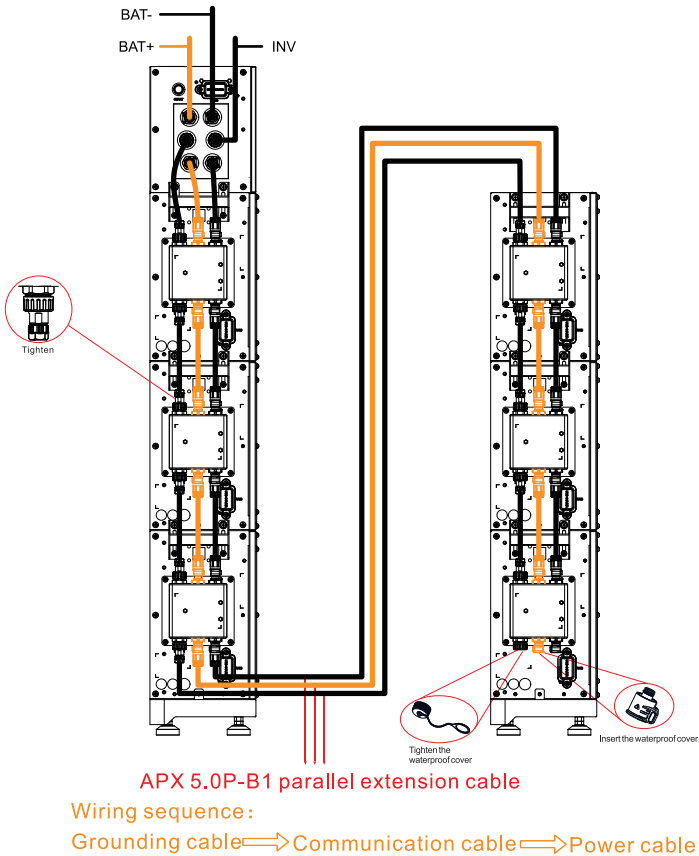

Note: When wiring the communication cable, remember to tighten the protective cover of the communication cable; otherwise it might undermine the waterproof performance. (Water penetration caused by failure to do so is beyond the scope of warranty.)

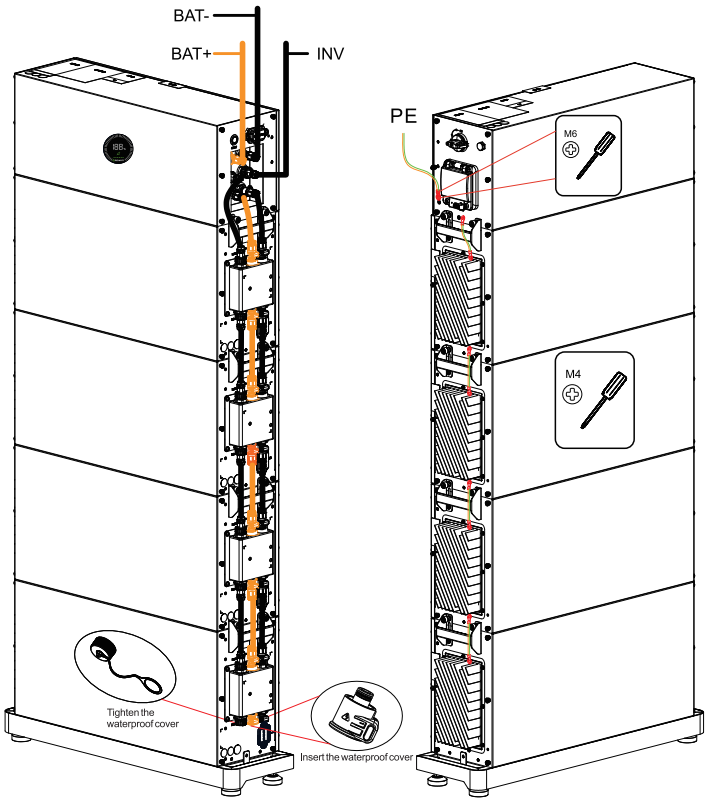

Note: It is not recommended to install a DC circuit breaker between the battery system and the INV . if you want to install a DC circuit breaker with rated working voltage greater than 600V and rated working current greater than 63A, do not operate the DC circuit breaker with power on, otherwise the machine may be damaged.

5-5 Routing cables out of the cable hole

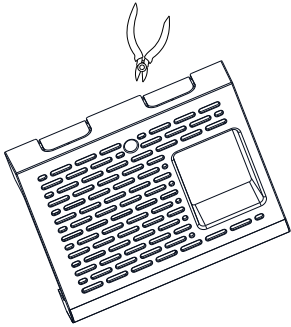

APX 55027-P0 Left trim-cover

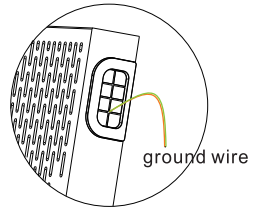
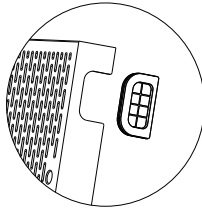

ground wire

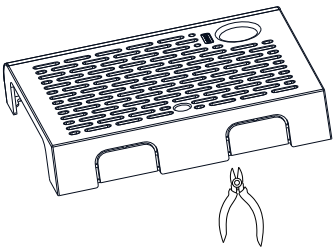

APX 55027-P0 Right trim-cover

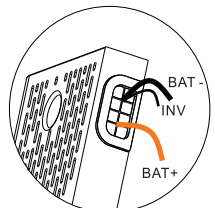
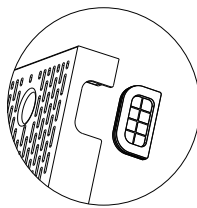

BAT-
INV
BAT+

5-6 Communication port connection

APX 5.0-30.0P-S0			(MIN 2.5-6KTL-XH/MIN 2.5-6KTL-XH2)		
Silk screen	Terminal serial number	Definition	Silk screen	Terminal serial number	Definition
INV	1	WAKE-(W-)	SYS COM	1	Enable-
	2	WAKE+(W+)		2	Enable+
	7	RS485_B(B)		7	BAT_B
	8	RS485_A(A)		8	BAT_A

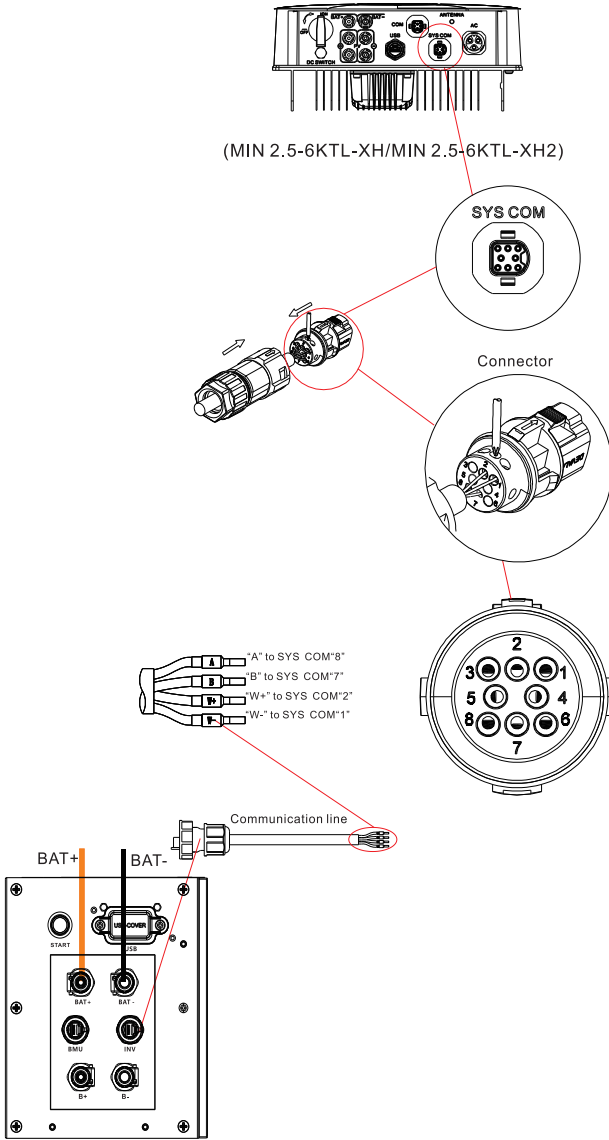

Note :When wiring the communication cable to the inverter, connect it to PIN 1, 2, 7, 8 of the INV-COM terminal first.

6. Terminal connection

6-1 Power terminal

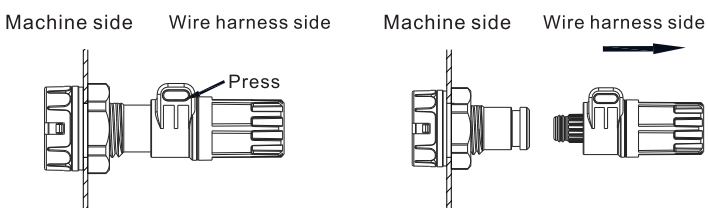

Note: Press the position indicated in the figure above before disconnecting the power terminal.

6-2 Installing the trim-cover

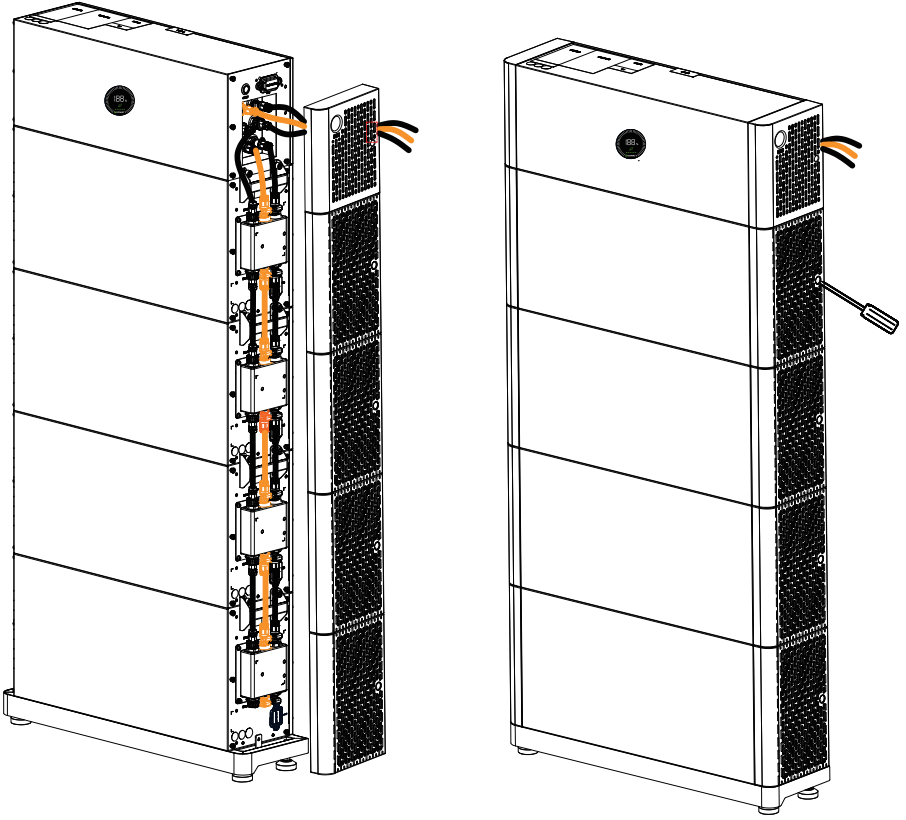

7. Powering on/off the battery system

Power on	1. Turn on DC Switch 2. Press the start key more than 5S	
System off	Turn off DC Switch (wait for over 90s)	

Note: 1、 Before performing maintenance and repair work, ensure that the AC circuit breaker and the PV switch of the PCS, as well as the switch of the APX are disconnected. Wait for 15 minutes after the system is powered off and make sure that the LOGO (GROWATT) indicator on the APX is off. Do not perform any operations until the system is completely shut down.

- When multiple battery systems are used in parallel connection, you only need to press the start key of and module to start the system.
- The content of this document is continually reviewed and amended, where necessary. Growatt reserves the right to make changes to the material at any time and without notice. Unless otherwise agreed, this document is for quick installation guidance only. All information and suggestions in this document do not constitute a warranty of any kind, express or implied. Growatt reserves all rights for final interpretation.

8. Service and contact

Shenzhen Growatt New Energy Co., Ltd
 4-13/F, Building A, Sino-German(Europe) Industrial Park,
 Hangcheng Blvd, Bao'an District, Shenzhen, China

+86 755 2747 1942 service@ginverter.com

W: www.ginverter.com



Download
Manual



Search Growsatt New Energy

GR-UM-379-A-01 (PN:044.0128100)